

# DIAGONAL

FOCUS

# Soil: Precious dirt at our feet

No. 2  

---

15

**Bark beetles:**

Following the  
forecast on screen,  
p. 25

**Energy transition:**

The canton of  
Aargau as a model,  
p. 26

**Tunnel entrances:**

Better protection  
against snow  
overhangs, p. 29

## EDITORIAL

Dear readers,

The United Nations declared 2015 to be the International Year of Soils in order to highlight the enormous importance of soil for both natural ecosystems and our food production. This is reason enough to take a look below the earth's surface in this issue. Twenty years ago, soil was still largely unknown territory. While a fair amount was known about its composition, almost nothing was known about the organisms that live in it. Researchers, including those at WSL, have made great advances in recent years. For example, new research methods have taught us that there are more organisms living in a handful of soil than there are people on earth.

Housing developments that literally shoot up out of the ground, pollutants in the air, heavy machinery that compacts the soil – this hidden habitat is under threat on numerous fronts. For this reason, the contribution research makes to protecting this resource is all the more important. Because soil is the basis of life – both now and for future generations.

We hope you enjoy reading this issue.



Prof. Dr. Konrad Steffen  
WSL Director



# 2

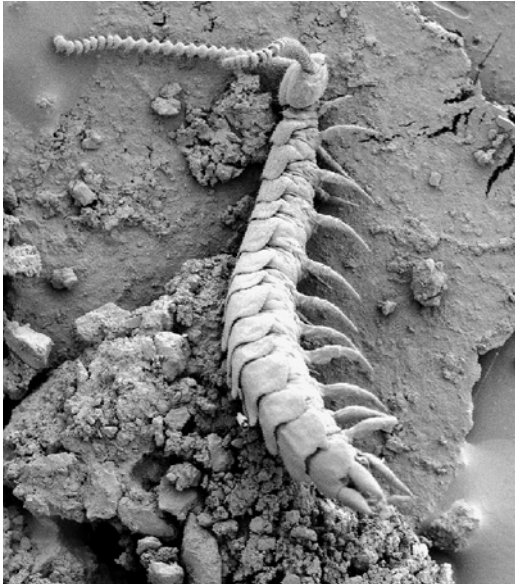

## SOIL – PRECIOUS DIRT AT OUR FEET

A lot of strain is being placed on our soils. What are researchers doing to ensure that the most important basis for life is preserved?

# 8



## BOG SOILS

Changes in raised bogs in Switzerland reveal how bogs in the far north might be modified by climate change.

# 14



## ONE-TWO

Gaby von Rohr, Office for the Environment, canton of Solothurn: “Conflicts over soil use will intensify in the coming years.”

# 18

## LONG-TERM FOREST ECOSYSTEM RESEARCH (LWF)

WSL has been examining how various environmental effects are changing the forest and its soil since 1994.



### KEY TOPICS

- 22** Biodiversity
- 24** Forests
- 26** Landscapes
- 28** Natural hazards
- 30** Snow and ice

### PORTRAITS

- 21** Dominik Brödlin, biologist
- 32** Heike Lischke, biologist
- 33** Cornelia Accola-Gansner, geoscientist

### SUSTAINABILITY REPORT

- 34** Environment
- 35** IMPRINT, OUTLOOK
- THE OBJECT**
- 36** Lab-microtome

A scanning electron micrograph (SEM) showing a dense population of soil bacteria. The bacteria exhibit various shapes, including rod-like, oval, and more complex, branching structures. The background is dark, highlighting the intricate details of the microbial life.

FOCUS Soil is the basis of our existence. How can research contribute to the sustainable use of this scarce resource?

# Soil: Precious dirt at our feet

Soil contains an enormous diversity of bacteria – between 5000 and 7000 species in a gram of soil typically a few micrometers in length.

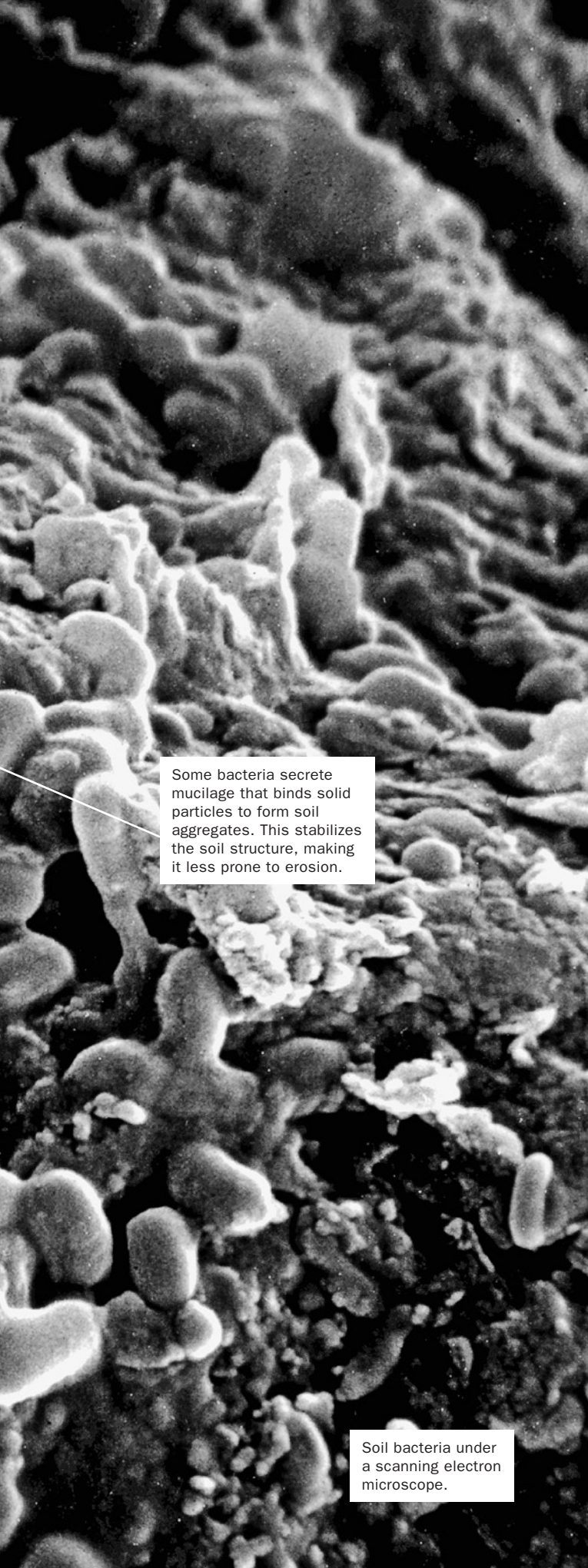

Some bacteria secrete mucilage that binds solid particles to form soil aggregates. This stabilizes the soil structure, making it less prone to erosion.

Soil bacteria under a scanning electron microscope.

Photo: Thilo Eichhorst & Rolf Tippkötter, www.micropeed.uni-bremen.de

What do you think of when you hear the word soil? Do you smell the moist, slightly musty soil of the forest? Do you feel the dried earth in your hands from your gardening? Do you multiply land prices by square meters in your head?

From an environmental perspective, soil is the foundation of life. It has been formed over thousands of years from bedrock through the interaction of climate and organisms, primarily countless fungi, bacteria and plants. It holds back rainwater, stores nutrients, is the habitat for thousands of creatures and serves as a carbon sink. However, if new housing and roads are built, if pollutants penetrate into the ground, or if heavy machinery damages the soil, it loses the ability to perform these functions in the ecosystem. It takes decades or even centuries for damaged soil to become fertile again – in terms of human life, soil as a natural resource is not renewable.

### **Soil in storage containers and databases**

WSL has a long tradition in looking at the properties of soils and the processes that occur below ground. It is currently involved in several projects as part of the National Research Programme “Sustainable Use of Soil as a Resource” (NRP 68) and is preparing guidelines on how society can sustainably use soil, which is a scarce resource. WSL began developing a comprehensive archive of soil and rock samples in the 1980s. From 1983 to 1985, employees of the first Swiss National Forest Inventory (NFI) collected 12,000 samples on a 1 × 1 km grid in the forests of Switzerland, one sample each from the topsoil. They dried the soil, sifted it and packed it in →

clear storage containers. From the initial analysis of the material, the researchers prepared a map with the pH values of the soils in Swiss forests. After the Chernobyl nuclear reactor accident in 1986, WSL collaborated with the Paul Scherrer Institute (PSI) to determine the extent and distribution of radioactive contamination – it was able to do so thanks to the soil samples, which served as a reference for the time prior to the accident. The WSL archive of soil samples, the “soil library”, now houses more than 72,500 soil samples. Most of these samples are in the WSL basement in Birmensdorf. The space was too small for the samples from the first NFI, so they are now housed in a former ammunition bunker of the Swiss army in Zuzwil (canton of Aargau).

But WSL does more than just offer a physical location for storing forest soils. Its database also includes information about the chemistry, physics and structure of samples from more than 1,000 soil profiles as well as data about vegetation, climate and geology. The database is used for various projects. For example, Frank Hagedorn, a geoecologist at WSL, uses them in one of the WSL projects conducted as part of NRP 68. He and his team study which factors control carbon stocks in Swiss forest soils. To do so, the researchers compare the measured carbon content of the soil samples with data about the climate as well as agriculture and forest management. The goal of the project is to better understand how soils function as CO<sub>2</sub> sources and sinks. The aim is to be able to model the carbon cycle more precisely. The initial results show that climate and the combination of tree species have the greatest impact on how much carbon is currently stored in the soil.

### **Dense and compacted**

The Swiss Central Plateau is a densely populated region. For example, the settlement area increased by 23.4 % from 1985 to 2009, which is equivalent to roughly 82,000 soccer fields in 24 years. Agriculture places a heavy burden on the soil as well. An overview of the properties and functions of the soils in Switzerland is an important basis for planning and decision-making to ensure prudent decision-making. So researchers at WSL and the Swiss Federal Institute of Technology (ETH) are working within the scope of NRP 68 to develop scientific principles for creating high-resolution maps of soil properties.

Compaction is a problem in forests as well: heavy timber harvesting machinery, horse hooves and mountain bike wheels compact the soil. The soil structure changes under the pressure of footsteps and tires. Air-filled cavities are disappearing, meaning rainwater can no longer drain and instead collects in pools. Bacteria, fungi and earthworms are literally left with no air to breathe. If there is no diversity in the soil, it's less fertile, matter decomposition and humus formation is interrupted and, in some cases, this type of soil releases gases that can contribute to climate change. Beat Frey, a microbiologist at WSL, and his team demonstrated that the composition of bacteria and fungi in the soil underwent long-term changes after being driven over and that this composition can be used as an indicator of the damage done to the soil.

We still have not decoded all of the processes and functions in the habitat at our feet. But it is clear that human activity should avoid damaging the functions of soils as much as possible. Only in this way can we ensure that the most important basis of existence is still around in the future. *(lbo)*

More information  
on soil research  
at WSL:  
[www.wsl.ch/more/  
soil](http://www.wsl.ch/more/soil)



The structure of forest soil changes greatly under the pressure of tires. Air and water no longer circulate, which has a negative impact on fine roots and soil organisms.

A wide-angle photograph of a rocky glacier forefield. The foreground and middle ground are filled with numerous grey, angular rocks of various sizes, interspersed with patches of green moss and small plants. Two vertical soil sampling markers, each with a black top and a grey base, are placed in the field. In the background, a steep, grey, rocky slope rises, showing signs of glacial retreat. A white line points from the text box to the right side of the image.

Due to the ongoing retreat of glaciers over the last several decades, a soil chronosequence can now be found in the glacier forefield.

A close-up view of a soil sampling marker, a vertical grey rod with a black top, standing in a rocky area. The ground is covered with green moss and small plants growing between the rocks. A white line points from the text box to the marker.

Microorganisms extract carbon and nitrogen from the air and release micronutrients from the stones. This allows the first plants to be able to grow here after a few years.





Microorganisms are the first organisms able to colonize this rocky desert. Just a few years after the ice has melted, some 1,500 organisms can already be found in the soil.

Forefield of the Damma Glacier (canton of Uri).



In the Le Forbonnet raised bog near Frasné in the Jura mountains of France, open top chambers simulate climate warming on a small scale.

# REPORTAGE Climate change threatens bog soil – and bogs increase climate change

The raised bog that glistens in the sun has neither sirens nor warning lights. Yet it acts as a warning system: an early warning system that indicates how the vast bogs in the northern regions of the planet could be modified by climate change – with an impact on the world’s climate. WSL researchers Alexandre Buttler, a professor at EPFL, and Luca Bragazza, a professor at the University of Ferrara, work on this magnificent early warning system near Frasné in the Jura mountains of France. They don’t look very professorial today: they’re wearing rubber boots and work clothes, and carrying oversized drills and high-tech devices along a small wooden walkway across the bog, where the first plants are beginning to sprout up. The water shimmers among the plants, mainly red and yellow peat mosses. Because it is so soon after the snowmelt Le Forbonnet raised bog is literally full to the brim with water. Buttler’s hand disappears into the squishy soil and pulls out a slimy mass. “The green ones are the living peat moss plants. The yellow section with the strands in it are what’s left from the last two, three years; you can still see stems of the moss plants in it. It’s known as blond or white peat,” he explains.

## **Raised bogs store a lot of carbon**

He and Bragazza now pick up the drill. Working together, they screw the 1.5-m-long tubes into the ground. Then they remove the drill. “That was easy – too easy,” says Buttler. And he’s right: the bog soil isn’t ready to reveal its inner secrets yet; the drill core has come out of the drill and is stuck in the ground. “When the ground is soaked, you almost never get a sample out of it,” notes Buttler, and he moves a few meters away to try again – in a somewhat drier area, where the pine forest slowly edges into the bog. This time, it’s more difficult to remove the tube. Using a sort of giant pipe cleaner, Buttler pushes the drill core into a second tube that opens lengthwise. Bragazza opens it. In addition to living peat moss and blond peat, there are also a few centimeters of black peat from the deeper layers. “This is where the atmospheric carbon that the peat mosses pulled from the air decades and centuries ago is stored,” explains Bragazza. “Because there is a lack of oxygen in raised bogs and because peat mosses contain substances that inhibit degradation, the plants are barely decomposed. So the raised bog grows a little more each year.”

This peat accumulation makes raised bogs to act as carbon sinks. Around the world, they store nearly a third of all soil carbon stock, although they only cover 3 % of the earth’s surface. The peat layer at Le Forbonnet is about four meters deep. Bragazza compares it to an 8,000-page book that grows by a page each year and records information about the climate and pollutants at the time of formation. Like Buttler, he has been researching the raised bog habitat since he completed his dissertation.

It is a habitat that has become rare in Switzerland. Over the last 200 years, humans have destroyed 95 % of raised bogs through drainage and peat extraction. Today, there are only about 1,500 hectares of raised and transitional

The photo gallery for this story can be viewed at: [www.wsl.ch/more/photos-bogs](http://www.wsl.ch/more/photos-bogs)

bogs; this is about the size of 20 golf courses and is insignificant in global terms. “Because Switzerland is climatologically on the southern distribution boundary of raised bogs, our bogs are particularly good as early warning systems for the consequences of climate change,” says Buttler. “In addition, they are small and therefore susceptible to strong boundary effects.” This means, for example, if the ground is dry enough for trees to grow, a bog that is a couple hundred meters in diameter will quickly become overgrown with trees – or at least the seeds of the trees are present.

### **Climate change leads to the destruction of peat**

Things are different in Siberia, where bogs can be dozens of kilometers in diameter. Bragazza warns: “If it gets warmer and drier in the summer, it’s not only the vegetation that will change. More plant material will be decomposed than is produced. The bog will start releasing carbon instead of storing it.” He removes a probe from a cylinder-shaped cover, attaches it to a measuring instrument and lowers the slowly buzzing instrument to the bare ground. He measures the smallest changes in the carbon content of the air at ground level. “This is how we measure soil respiration. And how microorganisms break down the peat.” The microorganisms aren’t very active today. But Bragazza’s research reveals that the peat body in Le Forbonnet is releasing carbon throughout the year – unlike the past few thousand years. His studies in two other bogs show that with the climate warming a larger amount of older carbon is released than had previously long been stored in the ground as peat. The changing climate could therefore lead to a reduction in peat accumulation in many places. However, it is still not clear whether the released carbon dioxide will further heat up the atmosphere as a greenhouse gas because the trees that are now growing there may store the carbon for a few more decades or centuries. So researchers from the University of Orléans plan to set up an eddy covariance flux tower in Le Forbonnet. This complex installation can measure the carbon balance of the entire bog, including the trees.

### **Jura – Poland – Siberia**

Together with their French colleagues, Buttler and Bragazza installed a set of open top chambers in Le Forbonnet seven years ago. These hexagonal plexiglass structures leave solar radiation, rain and wind largely unchanged, but they reduce heat emissions during the night thus passively simulating climate warming. The advantage of such experiments is that researchers can compare the manipulated surfaces directly with the unmodified neighboring surfaces. But they also have important disadvantages: the conditions are ultimately artificial, because these “new” conditions have only existed for a relatively short period of time, and only small areas can be influenced – especially in bogs, as they have stringent protections. Bragazza and Buttler therefore rely on a number of different methodological approaches. In the Jura and the Alps, they examine bogs at different altitudes. At low altitudes, it is relatively warm and the amount of precipitation is fairly low. The conditions are therefore similar to those that will probably exist at higher altitudes in a few decades as a result of climate change. The spatial gradient serves as a model for the development over time of bogs under changing climate conditions. The same applies to research areas



Alexandre Buttler (left) and Luca Bragazza (right) take a soil sample in order to investigate how climate change is transforming raised bogs from carbon sinks to carbon sources.

in Polish and Siberian bogs, where WSL researchers work with regional partners to investigate whether our bogs, which are characterized by a fairly oceanic climate, react differently to climate warming than bogs in a continental climate. “In Poland we work with a professor who was a postdoc with us in Lausanne,” says Buttler proudly. The Mukhrino bog in Siberia is in an even more continental climate, about 2,600 km or a three-hour flight east of Moscow. Working with French and Russian colleagues, Buttler and Bragazza laid kilometers of cable, built walkways and installed open top chambers themselves; once, a Russian colleague delivered the bog soil samples by train and car to France – a trip that took several days and which his European colleagues only learned about when the Russian appeared at their door with the frozen samples in his luggage. The samples are currently being analyzed.

Even without these analyses, early warning systems like Le Forbonnet have already made one thing clear: climate change is altering – endangering – raised bogs. The WSL researchers now want to understand the precise mechanisms. “The crazy thing is that climate change is triggering processes in bog soil that are increasing the release of carbon,” explains Bragazza. “These processes are

based on the complex interaction among plants, fungi, bacteria and abiotic factors. We need biogeochemical analyses of samples from the field and from experiments in the lab in order to understand these processes in detail.”

### **Raised bogs and climate change influence one another**

For example, there is increased growth of plants of the heath family (Ericaceae). Dwarf shrubs reduce the water content of the bog soil. Because they sometimes have long roots, unlike the rootless peat moss, their water supply does not suffer with the warming. In addition, they release substances from the roots that, together with the oxygen extracted from the air, contribute to the decomposition of the peat. And they bring some of their “partners” along with them: mycorrhizal fungi. With their help, they can use nutrients such as nitrogen more efficiently, grow faster and outcompete weaker peat mosses. This increases their influence and thus the primary impact of climate change: the bog releases even more carbon, which further fuels the greenhouse effect. A positive feedback loop, as scientists call such self-reinforcing processes – or a downward spiral, as the rest of us would say.

What does all of this mean for Le Forbonnet? Will it still glisten in the sun in a hundred years and conjure up a bit of Nordic feeling in the Jura mountains? Buttler and Bragazza contemplate this as they pack up their instruments. “It depends on whether the trees are cut down or not,” Buttler points out. A hundred years ago, this response would have been absurd – trees could hardly have grown there. But they do now and will in the future. The early warning system is already silently sounding.

*(bio)*

Hiking in the Sören-  
berg moorlands (in  
German):  
[www.wsl.ch/more/  
wandern](http://www.wsl.ch/more/wandern)

# Using mycorrhizal fungi to stabilize soil

Soil erosion and landslides can often be prevented through natural methods. WSL examines the role of mycorrhizal fungi strengthening the soil and providing nutrients to plants.

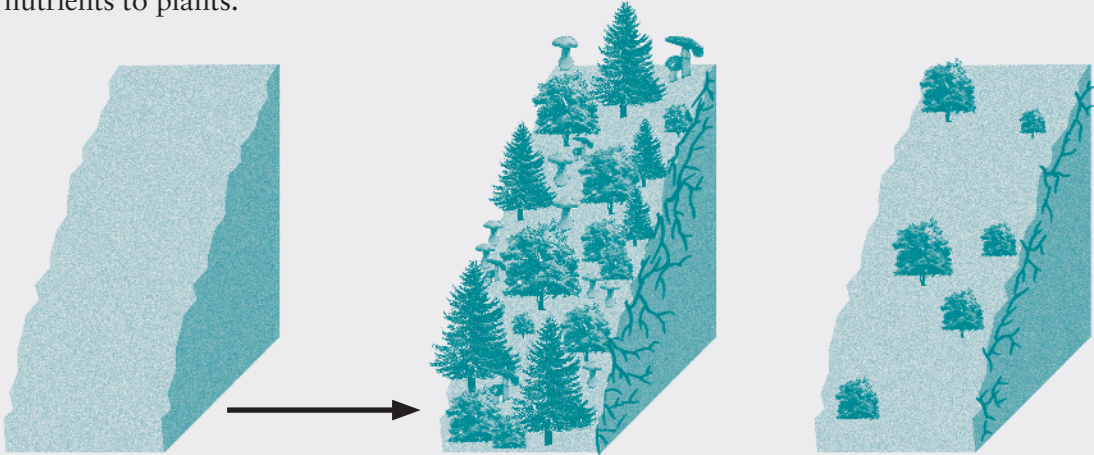

**LANDSLIDES** often result in barren soil. The soil is left exposed to the elements and may slide even further down the hill.

**WITH** the help of mycorrhizal fungi a protective vegetation cover grows more quickly.

**WITHOUT** mycorrhizal fungi, new plants have a hard time and colonize the soil only very slowly.

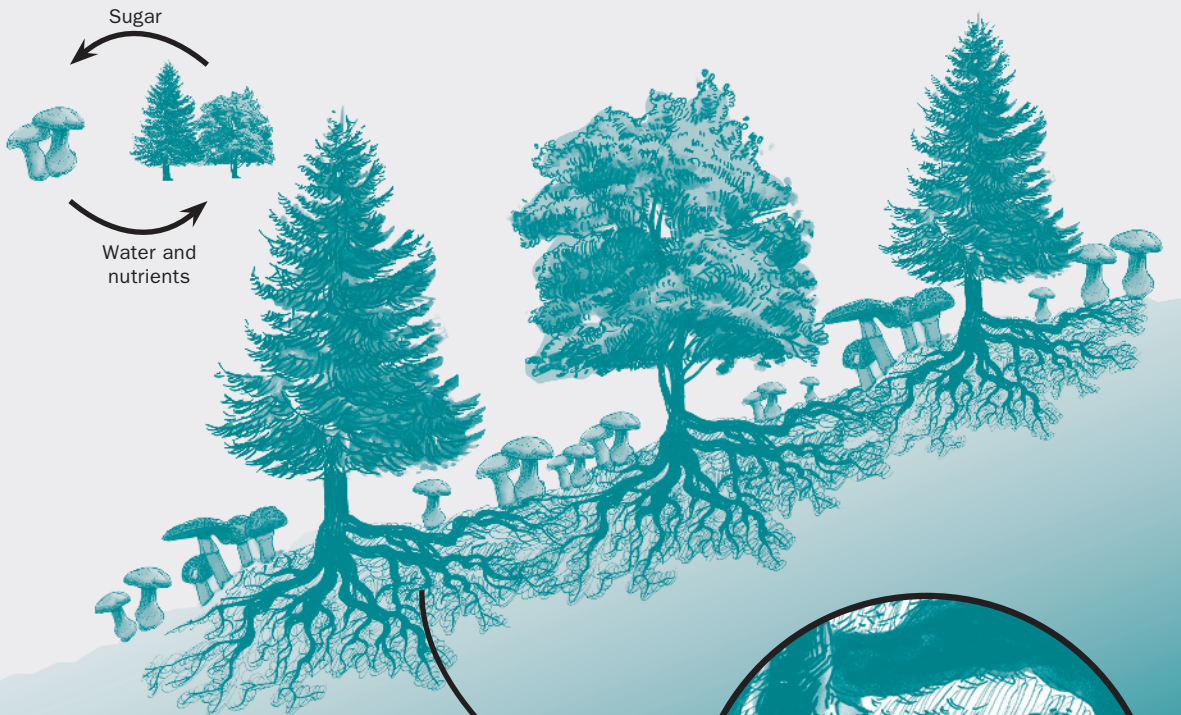

## HOW DO MYCORRHIZAL FUNGI WORK?

The fungi penetrate the soil with long filaments and excrete a sort of glue that aggregates the soil. They also form a root symbiosis with the plants: the fungi help ensure that the plants receive sufficient water and nutrients, and in return they receive sugar. Thus, the fungi accelerate the colonization and growth of plants.

# ONE-TWO Why is soil protection becoming more and more important? A conversation with Gaby von Rohr, canton of Solothurn, and Stephan Zimmermann, WSL.

**Ms. von Rohr, what are the threats to our soil?**

von Rohr: Soils are exposed to chemical, physical and biological stresses. Chemically, pollutants can find their way into the soil. Physically, this means that soil becomes compacted or begins to erode, i.e., the topsoil and mineral soil are carried off. Biological risks include pathogens and genetically modified organisms. For this reason, the Environmental Protection Act and the federal Soil Pollution Ordinance call for protection of the soil from chemical, physical and biological stresses.

**How progressive is legislation in Switzerland compared to other countries?**

Zimmermann: Switzerland developed its environmental protection legislation very early on, and it has long played a leading role in Europe. Today, environmental protection legislation, for example in Germany, is as far along as legislation in Switzerland.

von Rohr: In terms of physical soil protection, I still see Switzerland as one of the leaders.

**Still, the ecology of many soils is damaged. How can we bring them back into balance?**

Zimmermann: Soils change over time. They are in what is called a dynamic equilibrium. There is no purely static balance in which everything remains the same over a long period of time. Take the

addition of substances that increase the process of natural soil acidification, for example. In Germany, for instance, they add lime at various locations in the forest in order to prevent further acidification of the soil. But this only has an effect in the top few centimeters; in deeper layers of the soil the lime can lead to an increase in acidification. The best way to prevent acidification is to reduce the release of pollutants at the source.

von Rohr: Soil that has been farmed can hardly return to its original balance. What's important is to take measures to prevent irreversible damage. That way, soil compaction can be avoided by assessing the risk of compaction and the impact of taking precautions before agricultural vehicles are used.

**How is your canton helping soil managers to improve soil quality?**

von Rohr: Soil protection essentially requires us to act preventively. We do this by providing information and advice, and by developing guidelines and brochures for soil conservation practices in the construction, agriculture and forestry industries. One important tool is our soil monitoring network. Those who take account of the latest information regarding soil moisture will avoid working the soil when it is too moist and thereby compacting it. The canton also provides soil maps online. These maps provide information that also



Gaby von Rohr, Deputy Director of the Soil Department at the Office for the Environment, canton of Solothurn



Stephan Zimmermann, staff member in the Forest Soils and Biogeochemistry research unit





Soil protection classes provide industry specialists with information about the properties of forest soil and how sensitive it is.

includes the compaction risk of the various soils. Some forestry operations have included these maps in their geoinformation systems.

### How can research improve soil protection?

Zimmermann: We look into what factors affect soil and how strong their impact is as well as define critical threshold values at which no damage is expected. We then adapt what we have learned so that it can be put into practice, for example, in classes for forestry machine operators. Questions regarding acidification or nutrient balances are also important. Here, the focus is currently on phosphorous. This important nutritional element could run out because the deposits for mineral fertilizers are slowly being depleted.

von Rohr: The WSL bulletin on physical soil protection is extremely

valuable for us. It serves as a guideline and is widely accepted as a decision-making aid.

### How bad is soil contamination in forests? What's the biggest problem?

Zimmermann: Our forests are looking much better than our farms. This is due to the ban on the use of additives, such as fertilizers and pesticides, as well as the prevention of air pollution, which is constantly improving. After years of research, providing information and education, physical soil protection is improving as well. This is mainly because the machines used to harvest timber are increasingly being routed over logging trails, which are used to transport felled trees to the forest road.

### And in agriculture? Does Switzerland have the damage caused by fertilizers and pesticides under control?

More information on the topic of soil protection can be found at:  
[www.wsl.ch/more/soil-protection](http://www.wsl.ch/more/soil-protection)



It isn't always possible to avoid leaving tracks in the forest – but damage to the soil can be limited through appropriate measures.

von Rohr: With respect to farming, we deal primarily with the physical impact. It's not possible to farm without affecting the soil. But even more intensive cultivation is putting an increasing strain on agricultural soils. We still know too little about the impact of pesticides on soil biology. In this regard, soil is still unknown territory.

**Agricultural land is still giving way to housing developments and roads.**

**Has soil protection failed here?**

von Rohr: No, qualitative soil protection has no impact in this regard. Land use planning is key.

Land consumption is a problem because it's growing faster than the population. According to new data from the Swiss Federal Statistical Office, agricultural land is being developed at a rate of 1.1 m<sup>2</sup> per second nationwide; the rate in the Central Plateau is 2.2 m<sup>2</sup>. The needs of society are too much. This is where land use planning and policy are needed.

Zimmermann: As part of National Research Programme "Sustainable Use of Soil as a Resource" (NRP 68), a decision-making platform for the sustainable use of soil is in the works, and WSL is involved



could be lifted, and buildings could be built upwards rather than outwards.

**Will conflicts over the use of land intensify in the next 10 to 15 years?**

von Rohr: Yes, definitely. The soil is facing assaults on multiple fronts. The more land that is lost, the greater the pressure on the remaining land and its quality. This also affects drinking water. And if crop rotation areas are better protected, as they should be, pressure will increase on those areas where crop rotation is not practiced.

**So is greater soil protection needed, and maybe more research as well?**

von Rohr: As soil advocates, our services will certainly be needed in the future as well. People are dependent on what the land provides. So the land needs to be protected. And because there are still a lot of unanswered questions in this regard, we depend on research findings with practical relevance and on the WSL with its practice-oriented research.

Zimmermann: There will continue to be a need for active soil protection. Conflicts over use will increase, as will pressure on the soil. Soil biology allows us to use new methods to understand how individual soil processes function. Soil has the greatest biodiversity of any environmental strata on the planet. As I see it, one of our core duties is to look into questions that have practical relevance and benefit society. *(rlä)*

in its development. This platform will show how different activities impact soil properties and functions. Tools like this can help us learn how to use soil carefully.

**How can we reduce land consumption?**

von Rohr: There are legal options including municipal planning and local building codes. For example, the restriction on building height

**“Soil has the greatest biodiversity of any environmental strata on the planet.”**

# LONG-TERM FOREST ECOSYSTEM RESEARCH    A look at soil – the close relation between soil water and forest growth

“The forest soil is fairly dry to a depth of 50 cm,” says Elisabeth Graf Pannatier, a soil researcher at WSL. It’s spring in this mixed deciduous forest in the Lägeren mountain range near Wettingen in the canton of Aargau. The scent of fresh wild garlic is in the air. The first leaves are beginning to appear on the low-hanging branches of the beech trees. Kneeling over a gray plastic box, the researcher checks the water levels in three glass bottles. Two of these three bottles, known as lysimeters, contain almost no liquid. If the soil contained more moisture at a depth of 15 cm and 50 cm, the collection devices would have sucked water in from the soil through the vacuum. The third bottle, however, contains about two deciliters of light yellow soil water from a depth of 80 cm. “Despite the lack of rain, the subsoil is still damp,” says the researcher. “Taking soil samples here would be destructive. These fixed collection devices allow us to take soil water samples from the same place over a long period of time and analyze them chemically in the WSL lab.” The nutrients that are dissolved in the water are particularly important, as they affect the growth of the trees.

## **A network of research sites**

At the Lägeren monitoring site, researchers record the rhythm of the forest in minute or hour intervals. This research site is part of the Long-term Forest Ecosystem Research Programme (LWF), which WSL conducts as part of the Swiss Forest Monitoring program (Waldbeobachtung Schweiz) along with the Swiss Federal Office for the Environment. The 19 LWF sites across Switzerland represent the most important forest communities and regions, the diversity of soils, and the different levels of air pollution that forests are exposed to.

At most sites, researchers have been investigating how various environmental disturbances like air pollutants, storm damages and extreme dry spells have been changing the forest and its soil since 1994. First, they documented the chemical state of the soils; since then, they have been measuring the quantity and composition of precipitation before it seeps into the soil. Back in the lab, they analyze leaves and needles collected in litterfall samplers. In doing so, they learn which nutrients are returned to the soil. They also collect other important data at regular intervals such as the sap flow and diameter variations of tree trunks and measure meteorological values such as air temperature and solar radiation. The measurements and an observation period spanning more than 20 years are of great importance.

## **Measuring the forest as a whole**

Watching Elisabeth Graf Pannatier as she checks the measurement devices in the forest gives a sense of her interest in the processes going on in the soil and their interaction with the trees and their environment. “We’re now in at the intensive site,” says the researcher. “Here, we measure the same factors several times across a grid covering 16 subareas. The numerous individual measurements



Elisabeth Graf Pannatier checks the volume of water sucked from the lysimeters.

show the spatial variability, and the average values are representative of the entire area.” When the researchers put all of this information together over a period of many years like the pieces of a puzzle, they can assess whether temporal changes affect the entire area. Individual series of measurements reveal long-term trends, making it possible to identify, for example, the relationships between the chemical quality of rain and that of soil water. For example, the sulfate concentration in soil water has decreased significantly as a result of improved air quality. Thanks to a reduction in the amount of sulfur in fossil fuels used in industrial furnaces and heating equipment, sulfur dioxide emissions

Information about the Long-term Forest Ecosystem Research (LWF) program can be found here: [www.lwf.ch](http://www.lwf.ch)

have also dropped sharply since 1980. By contrast, nitrogen emissions into the air remain high and often lead to high nitrate concentrations in the soil. This results in a loss of nutrients because the calcium, magnesium and potassium that are dissolved in the soil water seep into the groundwater or runoff with the nitrate and thus disappear from forest ecosystem. This can result in a gradual depletion of the soil, which in turn impacts plant growth.

The researchers at WSL provide much of this data, which is collected in accordance with internationally standardized methods, to colleagues abroad – primarily as part of the European Programme on the Assessment and Monitoring of Air Pollution Effects on Forests (ICP Forests). At the same time, the LWF researchers have access to data from some 800 measuring stations throughout Europe. “This way, we can compare the trends found in Switzerland with the trends in other regions,” says the researcher with enthusiasm.

### **From soil water to tree growth**

Thanks to technical developments, new soil measurement instruments are constantly shedding light on forest soils. “During the dry summer of 2003, we couldn’t measure how much water was still available for trees in Switzerland’s low-lying areas. The soil there was so dry that it was beyond the measurement range of the traditional tensiometer, which measures the soil moisture tension in the soil,” explains the soil expert. “But now we have electronic soil sensors.” These enable researchers to conduct research in much dryer areas and to measure the soil dryness at which trees stop growing. This is important information in view of climate change, as droughts and heat waves are likely to become more frequent.

Finally, thanks to the research at LWF sites researchers have learned a lot over the last two decades about how pollutants, droughts and climate change are affecting the forest ecosystem. “We expect that we still have a lot to learn about soil activity and the metabolic processes going on there. We’re therefore entering uncharted territory, and as a soil researcher this is very exciting for me,” says Elisabeth Graf Pannatier enthusiastically as she closes the box of lysimeters with the day’s readings.

*(rlä)*



Dominik Brödlin,  
Birmensdorf

“I grew up in the Markgräflerland, where the borders of Germany, France and Switzerland meet. I’ve always loved nature, both in and on the water, and as a child I spent a lot of time on the Rhine River. I really like the Türlensee. It’s a lot closer to nature and more peaceful than Lake Zurich.”

#### SCARCE PHOSPHOROUS

Phosphorous is an important nutrient for plants, but it is only found in limited quantities in nature. Dominik Brödlin’s dissertation at WSL examines the bio-availability of organically bonded phosphorous in soil solution in terms of ecosystem

nutrition. “What I enjoy about my project is that I work with researchers from a wide variety of institutions in Germany, and I can share experiences and knowledge with other doctoral students.”

# BIODIVERSITY Sycamore groves – tracing a traditional cultural landscape



To determine which species grow on sycamores, Thomas Kiebacher collected a total of 20,000 bryophyte and lichen samples.

The man who looks like Tarzan clambering in a tree is Thomas Kiebacher. Kiebacher has dedicated himself to sycamore trees, or more precisely sycamore groves – a traditional cultural landscape in the Swiss Alps. The biologist’s dissertation presents research into the biodiversity and cultural history of these habitats. Over the course of two years, he tested random samples of bryophyte (mosses, liverworts and hornworts) and lichen growth on 90 trees in Switzerland, Germany and Austria. He also examined ground vegetation and interviewed 22 locals about their experiences related to sycamore groves.

The initial findings show that freestanding sycamores are real

biodiversity hotspots, with up to 100 different species of bryophytes and lichens growing on a single tree, including numerous rare and endangered species, such as Rudolph’s trumpet moss (*Tayloria rudolphiana*). Kiebacher found a total of 264 bryophyte species under trees in the grove, which is equal to about a quarter of all known species in Switzerland.

## Preserving the bryophyte and lichen El Dorado

Sycamore groves also used to play an important economic role. In the Reichenbach Valley (canton of Bern), for example, the right to use the leaves of sycamore trees as bedding in cowsheds was auctioned off each year. These park-like groves now face the same fate as other traditional cultural landscapes: a growing scarcity due to over- or underuse. This has to change. Kiebacher says: “We will present our findings to a larger audience in a book being published as part of the Bristol publication series. The aim is to draw more attention to this neglected habitat and its organisms.” Thanks to Kiebacher’s work, a project to conserve sycamore groves is already underway in the Diemtigtal Nature Park (canton of Bern). The researcher hopes to advance other projects through the book. (chu)



# What ibex horns reveal about changed environmental conditions

Examining new objects with proven technology: Tree ring researchers analyzed the horns of Alpine ibexes instead of the usual trees. In doing so, an international team led by WSL was able to draw upon a unique dataset. The Office for Hunting and Fishing in Grisons has been measuring ibexes that have been shot in the canton since 1978, not only in terms of the overall length of their horns, but also the annual increments, i.e., how much the horns grow each year. Ulf Büntgen, head of the WSL study on the Alpine ibex says: “For us, this dataset has been a goldmine. It once again shows how important long-term measurement series are in environmental research.”

## Spring temperatures determine horn growth

The researchers analyzed the data of more than 8,000 ibexes from eight geographically separate populations. In doing so, they showed that the horns grew more in years with warm springs than in colder conditions, irrespective of the age of the animals. This points to a large-scale environmental factor that influences horn growth: Europe’s macro weather situation. Due to higher spring temperatures between March and May, snow now often melts earlier than it did 30 years ago, pro-

viding ibexes with a larger food supply and better quality grass and herbs. Thus, the animals can invest more in horn growth in years when the snow melts earlier.

The researchers are now using the dataset to determine whether other factors influence the development of the horns and physical condition, such as the type of hunting. *(lbo)*



The horns of the Alpine ibex are an important indicator of the environmental conditions in which the animal lives.

## FORESTS Tending young mixed deciduous forests promotes tree diversity

The more diverse a forest is, the better protected it is against climate change. If one tree species disappears, another may take over its function. But how can foresters influence the mix of tree species in a forest, and to what extent should investments be made in tending a young mixed deciduous stand?

WSL examined the effectiveness of various tending schemes in a young mixed deciduous forest near Diessenhofen (canton of Thurgau) from 2003 to 2014. The researchers used a seven-hectare area to test three tending options with varying levels of intensity, from extensive tending measures applied across the entire area to an option involving no interventions at all. They marked a total of 480 “future crop trees” – trees with desired charac-

teristics – and monitored their development.

The different tending options had no impact on how well the trees grew. But tree species that are less able to compete, such as oak, disappeared more frequently if left untended than when competition was kept at bay by removing neighboring trees. The more intensive the tending measures were, the more admixed deciduous tree species were maintained, including those able to endure a warmer and dryer climate. *(lbo)*

[www.wsl.ch/more/tending\\_measures](http://www.wsl.ch/more/tending_measures)



A cherry tree whose development the WSL followed on a test area in Diessenhofen (canton of Thurgau) for 11 years.

# Are the beetles on the fly? The bark beetle forecast on screen

When will the bark beetles hibernating in my forest district become active? When will the next generation of spruce bark beetles begin to develop, and when is the second generation expected? Until recently, these questions could only be answered through constant monitoring and many hours of prowling in the forest.

But the new WSL bark beetle forecast saves both time and money. Based on weather data that is updated daily and a model of the development of bark beetles, users can see in nearly real time how the flight of beetles will develop at a certain altitude and aspect in spring or summer, or what the beetle forecast for the end of season is. This information complements the monitoring



Galleries of European spruce bark beetle (*Ips typographus*), also known as the eight-toothed bark beetle.

conducted by the foresters and helps them in their beetle management efforts. (rlä)

Further information (in German):  
[www.borkenkaefer.ch](http://www.borkenkaefer.ch)

## Waldwissen.net – heading into the next decade with a new app

It was a simple idea ten years ago: to provide the forest managers with access to the voluminous but scattered body of research in one easy-to-access location. This led to the creation of [www.waldwissen.net](http://www.waldwissen.net), which has now grown to a good 3,200 articles, making it the most comprehensive forestry website in Europe. Waldwissen.net is operated by WSL and seven other forest research institutes in Germany, Austria and France. With more than 200,000 users per month, the website statistics show that a large number of people access the site. The statistics also reveal that more than a third of users now access

[waldwissen.net](http://waldwissen.net) from their mobile devices. In order to take account of this development and on the occasion of its tenth anniversary [waldwissen.net](http://waldwissen.net) was optimized for tablets and smartphones. Now there is an app to notify smartphone users about new articles when they're on the go. Articles can be read easily using the app, and the save feature lets users work with the articles at their PCs or laptops at the office. The Waldwissen app is free and waiting to be explored. (mmo)

Further information (in German):  
[www.wsl.ch/more/waldwissen](http://www.wsl.ch/more/waldwissen)

# Renewable energy case study: the canton of Aargau as a model for the upcoming energy transition



Photovoltaic system on the roof of a farm in Kallern (canton of Aargau).

As part of Energy Strategy 2050 plan, Switzerland has decided to reduce its overall energy consumption, produce an increased amount of renewable energy and phase out nuclear energy in the long term. This will especially impact the canton of Aargau, as it has three of the five nuclear plants in Switzerland: Beznau I, Beznau II and Leibstadt.

But what potential does renewable energy have in Aargau? In cooperation with the canton as well as AEW Energie AG and the Paul Scherrer Institute (PSI), WSL has put together a synopsis. A key question was the role that local resources, such as forest energy wood, might play in the future.

Several Aargau datasets (energy statistics, AGIS geo data, etc.) showed that about 60 % of Aargau's current energy needs are covered by local renewable energy sources, a level

roughly on par with the country as a whole. At 2,925 gigawatts per year, hydropower is the largest source of renewable energy. Another 1,100 or so gigawatt hours of electricity comes from solar energy, about 50 from wind energy and about 25 from micro-hydropower plants.

## Major energy reserves in forest energy wood

Biomass energy will play an important role in the future energy mix mainly because it can be used to produce electricity, heat and fuel when it's needed, so it's not dependent on the time of day or year. The additional electricity created by utilizing biomass could amount to some 145 gigawatt hours if no additional heat is produced and no fuel is produced. The largest biomass energy reserves are stored in forest energy wood.

Conclusion: The canton of Aargau can meet the goals of the national energy strategy in terms of electricity production primarily on the basis of renewable sources of energy. In this respect, it is a model for Switzerland. *(rlä)*

# How does the canton of Aargau intend to produce more energy from renewable resources?

**Mr. Morier, energy wood in Switzerland has great potential.**

**What can the canton do to use more energy wood from its forests?**

Whether more forest energy wood will be used depends on the wood market and the price of other types of wood, such as hardwood logs and pulpwood. Ultimately, the use of energy wood must be governed by price. The canton cannot and does not want to intervene in the wood market.

**Will the growing stock fall if the canton uses an increasing amount of energy wood?**

According to the Swiss National Forest Inventory, the total stock in the canton of Aargau decreased by about 6 % between 2004/06 and 2009/13. In order to sustain the current stock, we have to harvest less stem wood than previously because of the increased use of energy wood. For us, the increased use of energy wood is no reason to reduce the stocks.

**As an expert on forests, what do you think about wind turbines in forests?**

Wind turbines should be built in places where the wind speed is sufficiently high. Otherwise, it doesn't make sense. This is the case on Aargau's hilly terrain. The following areas were set aside for this purpose in the cantonal master plan: Burg, Hochrüti, Hundsrugge, Lindenberg, uf em Chalt. Because of the prohibition

against deforestation in areas with both open spaces and forests, wind turbines are generally built outside forest areas.

**What about solar energy? Where should it be produced?**

In the canton of Aargau, solar panels could be set up on the roofs of a number of homes, barns and industrial buildings. *(rlä)*



Wood can be used for energy in a number of different ways.



Alain Morier heads the Forest Division of the Construction, Transport and Environment Department in the canton of Aargau.

# Debris flow research: large landslides or small rivulets?



Environmental engineer Nicole Oggier monitors the Meretschibach debris flow region. The upper section, the Bochtür, is often shrouded in clouds of dust caused by falling rocks.

The steep slopes of the Bochtür are often shrouded in a cloud of dust. In the upper catchment of Meretschibach in Wallis, pebbles, stones and scree constantly slide down the mountainside. They amass slightly further down, sometimes in piles of up to three meters. At some point when it rains, these piles of rubble continue their journey north – forming a debris flow that makes its way down into the valley.

“We’re interested in when and how these kinds of debris flows are caused,” explains Brian Mc Ardell, team leader of the Mass Movements Unit at WSL. “How much water is needed to trigger the process? Do debris deposits suddenly break off, or does it start with a small rivulet that picks up more and more stones?”

McArdell and his colleague Nicole Oggier have been conducting in-depth research into this area since 2013. Weather stations record data relating to precipitation and snowfall. Radar and other remote sensing measurements reveal where the slope is moving the fastest. Meretschibach is a particularly interesting location, as its highly fractured rock face speeds up these processes, making them around 100 times faster than those on other slopes.

McArdell sums up their initial findings: “Lots of rills in an erosion area indicate that a debris flow was started by water. That’s typical of more gentle slopes. Steep slopes tend to have sudden slides, similar to an avalanche, in large homogeneous areas in the starting zone.” The research project is generating great interest in Wallis, as debris flow from Meretschibach frequently cause damage in the residential areas of Briannen and Agarn. *(bzi)*

[www.wsl.ch/more/meretschibach-en](http://www.wsl.ch/more/meretschibach-en)

# Dangerous snow overhangs: Making tunnel entrances safer for drivers

On February 1, 2014, there were snowdrifts and strong winds on the A13 in Rheinwald. In the late afternoon, a chunk of snow weighing approximately 10 kilograms broke off from the northern entrance of the San Bernardino Tunnel and struck a passing car. Although the impact caused heavy damage to the vehicle, the passengers walked away unscathed except for the fright they had received. The municipal works department for the canton of Grisons subsequently tasked the SLF with looking into how and on which tunnel entrances such snow overhangs form, and possible measures for avoiding accidents in the future.

## Precautions for the five most dangerous entrances

That same winter, SLF experts looked into how great the danger of falling snow overhangs is for all 38 tunnel entrances on the A13 in Grisons. “Snow overhangs form as a result either of wind, similar to snow cornices, or when snow settles,” explains Stefan Margreth, Head of the SLF Protective Measures research group. “A vehicle on the A13 is likely to be struck by falling snow every 30 years on average.” Five of the tunnel entrances that were examined were found to be particularly dangerous. So the experts recommended in particular that access for staff be improved so the overhanging snow can be removed as part of normal winter services. The experts also proposed installing heating bands at particularly critical entrances and that a snow drift fence be erected on the roof of the northern San Bernardino

entrance to prevent snow carried by the wind from piling up at the entrance. The hope is that these measures, which were implemented in summer 2014, will prevent further accidents. *(mbe)*

[www.wsl.ch/more/avalanche-protection](http://www.wsl.ch/more/avalanche-protection)



Snow can slide onto the road from steep surfaces over tunnel entrances, as shown here at Lukmanier Pass.



A chunk of snow that fell from the northern entrance of the San Bernardino Tunnel caused extensive damage to this vehicle.

# SNOW AND ICE Expedition to Greenland: studying perennial snow cover using radar, the SnowMicroPen and weather stations



The Swiss Camp is a sort of headquarters for the weather monitoring network on Greenland's ice sheet.



Martin Schneebeli examines the snow cover near a weather station using the SnowMicroPen.

Greenland in May: It never gets dark, and it's a relatively pleasant  $-20$  degrees Celsius on the enormous ice sheet. The perfect conditions for WSL Director Koni Steffen to check on his weather stations. Steffen has built up Greenland's first and only weather monitoring network over the last 25 years. This network enables researchers to observe Greenland's climate and the changes that are taking place there.

## Greenland is thawing

The 20 stations are located on a massive ice sheet – at 53 times the size of Switzerland, Greenland is the world's largest island; more than four-fifths of its surface is covered in ice. The



Swiss Camp, which is the control center of the monitoring network, is located at the western slope of this ice sheet at 1,100 meters above sea level. When Steffen set it up, it was at the so-called equilibrium line. This is where the same amount of snow falls as melts over the course of the year. But climate change has pushed the equilibrium line upward. The camp, which is anchored to the ice with long wooden posts, demonstrates this more impressively than temperature measurements: Each year, the “ground” below melts away; the posts become stilts, requiring time-consuming stabilization work. While this may be an annoyance for the local researchers, it’s a phenomenon with global significance. Greenland loses some 350 cubic kilometers of ice every year – five times as much ice as the volume of all glaciers in the Alps combined. The snow melt causes the sea level to rise – a major threat to regions of the world that have flat coastlines.

Back to Greenland: The stations Steffen has set up around the ice sheet send hourly weather measurements to a server via satellite year round, virtually making the data available in real time. But people have to visit the stations once a year to make sure everything is in good order. This May, Steffen was accompanied on his flights and snowmobile trips to the stations by three SLF snow researchers. Martin Schneebeli and Martin Proksch were interested in the snow cover, some of which is perennial. They dig countless snow profiles and use a variety of tools, especially the SnowMicroPen – an SLF invention involving a probe that bores into the snow with an extremely pressure-sensitive tip and measures penetration resistance.

Schneebeli explains: “Using these measurements, we check whether we can use weather data and our computer models to evaluate the snow cover as we found it in nature. This may help us understand snow climatological developments in Greenland.”

### **Radar in the snow**

Lino Schmid wants to uncover the secrets of the snow cover as well. He has installed special radar instruments in two locations – the Swiss Camp and the US research station located at the summit, 3,216 meters above sea level. They typically illuminate the snow from below, without destroying it. But Schmid had to turn the device upside down at the Swiss Camp: Since the equilibrium line began moving up, the area of course began seeing a lot more snowmelt than snowfall. So Schmid mounted the device on a pylon and now examines the snow cover from above. And whether they’re upside down or right-side up, the two radar instruments will provide regular data about the snow cover, such as information about the layers that make it up, year round – even during the raw Greenland winter. “This is a valuable addition to our weather data,” notes Steffen with satisfaction. *(bio)*

Further information (in German):  
[www.wsl.ch/more/groenland](http://www.wsl.ch/more/groenland)

A woman with short grey hair and glasses, wearing a purple and white striped t-shirt and dark pants, sits on a large, moss-covered rock by a river. The river flows through a lush green forest. The sky is clear blue. The scene is peaceful and natural.

Heike Lischke, Birmensdorf

“I enjoy wild, unspoiled nature and the dynamic interplay of water and forest found here in the Gnadenthal. The riverscape looks different every time I come here. Sometimes there’s human intervention; this section of the Reuss River was restored a few years ago.”

#### ECOLOGY IN TIME AND SPACE

How might the forest, landscape and biodiversity change in the future? Answering this question often requires a lot of mathematics. Heike Lischke, Head of the Dynamic Macroecology group, finds it interesting to transform the theories in her head

into mathematical formulas and use these to develop vegetation models. This makes it possible to get closer to the real ecology. “Mathematics can help us better understand the complex processes in nature.”

A woman with shoulder-length brown hair, wearing a vibrant red long-sleeved top and dark pants, stands in a sunlit grassy field. Her right hand is on her hip, and she looks directly at the camera with a slight smile. The background features rolling green hills and mountains under a clear sky, with a chairlift visible in the distance.

Cornelia Accola-Gansner, Davos

“For me, this spot near a chairlift symbolizes what makes Davos so unique – it’s both rural and touristy. Since it’s only some 50 meters from our house, I come here frequently with my children and enjoy the amazing view of the Landwasser valley.”

#### COMMUNICATING WITH THE PUBLIC

Cornelia Accola-Gansner has worked in the SLF communication group for 15 years. Working at the intersection between research and the public, the geoscientist organizes events, responds to media inquiries, leads groups on tours through

the building and answers all of the various questions that are received by mail or phone each day. “Avalanche prevention is particularly important to me, since I often go ski touring in the mountains.”

In its environmental report, WSL discloses how environmentally friendly its operations are. It set the following three goals in 2006: to reduce energy consumption by 10 % per employee by 2016, and to decrease heating per m<sup>2</sup> by 40 % and fuel consumption per 100 km by 20 % by 2020.

WSL is currently on track to meet these goals – and even exceeded the interim goals it set for 2014, with 5 % less for heating, 12 % less for energy consumption and 21 % less for fuel consumption. The research institute even increased its energy efficiency per FTE position by 40 % between 2006 and 2014.

WSL mainly uses energy in the form of electricity (48 % of its total energy consumption). After decreasing each year since 2009, overall energy consumption rose slightly again

in 2014. The reason for this was the construction of the new high-tech plant protection laboratory, which was built in 2014 in accordance with the Minergie-Eco standard. This is the first timber construction high-security lab in Switzerland, and the heat waste it produces is fed into the WSL network.

WSL not only pursues its own goals and measures – it also participates in various environmental and energy programs, such as the program for resource and environmental management within the Swiss federal administration (Ressourcen- und Umweltmanagementsystem der Bundesverwaltung – RUMBA), The Confederation: Exemplary in Energy, and the Energy Agency of the Swiss Private Sector (Energieagentur der Wirtschaft – EnAW).

(azu)

**Total WSL energy consumption**

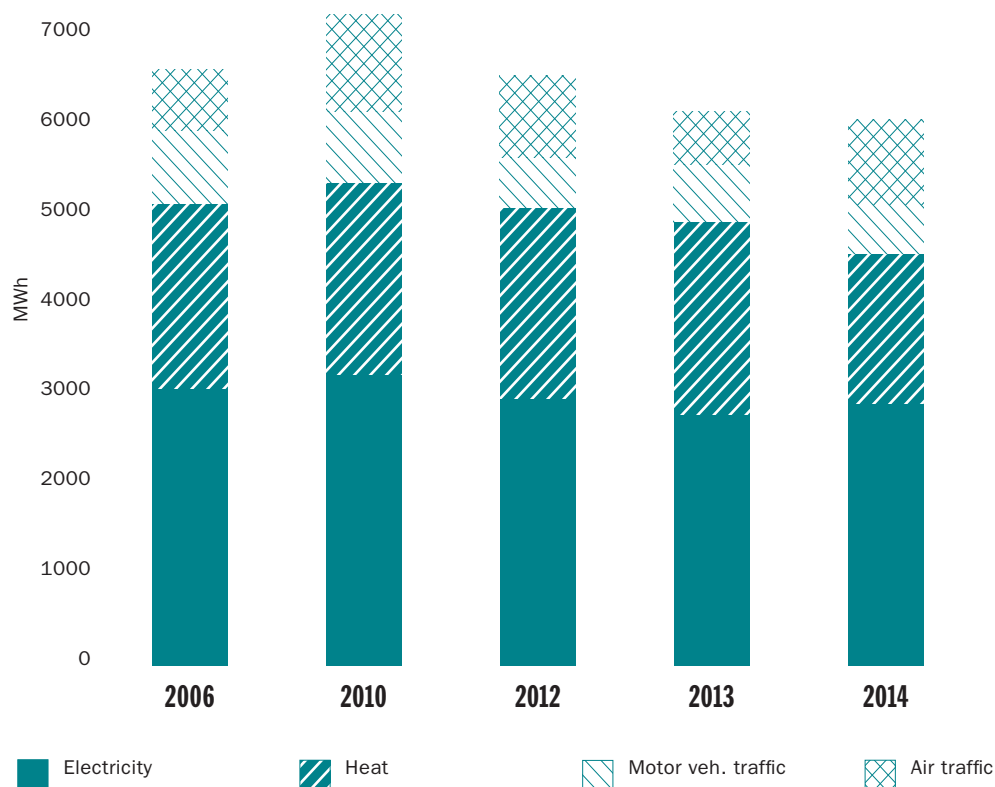



An artificially triggered avalanche in Vallée de la Sionne provides a vast volume of data. This data will help SLF researchers better understand avalanche dynamics.

February 2015: SLF researchers trigger three avalanches in Vallée de la Sionne (canton of Valais) as part of a large-scale experiment. A pylon equipped with sensors placed in the middle of the test site provides important data for studying the speed, pressure and range of avalanches. In addition to this site, WSL operates other unique test sites where researchers study debris flows, rockfall and sediment transport in streams and rivers under natural conditions. There are also major long-term experiments underway in forests in order to better understand processes in nature and adapt management methods accordingly.

DIAGONAL can be ordered free of charge: [www.wsl.ch/diagonal](http://www.wsl.ch/diagonal)

Request individual copies:  
Swiss Federal Research Institute WSL  
Zürcherstrasse 111,  
CH-8903 Birmensdorf  
[eshop@wsl.ch](mailto:eshop@wsl.ch); [www.wsl.ch/eshop](http://www.wsl.ch/eshop)

---

## IMPRINT

Publisher:  
Prof. Dr. Konrad Steffen, WSL Director

Text and editing:  
Lisa Bose (lbo), Sandra Gurzeler (sgu),  
Martin Heggli (mhe), Christine  
Huovinen (chu), Reinhard Lässig (rlä),  
Martin Moritz (mmo), Birgit Ottmer  
(bio), Bärbel Zierl (bzi), Andreas  
Zurlinden (azu)

Editorial management:  
Lisa Bose, Christine Huovinen;  
[diagonal@wsl.ch](mailto:diagonal@wsl.ch)

Translation: Supertext AG, Zurich

Design:  
Raffinerie AG für Gestaltung, Zürich

Printing: Sihldruck AG, Zürich

Circulation and frequency of  
publication:  
500, twice annually

The WSL magazine DIAGONAL is also  
published in German and French.

Cite as:  
Swiss Federal Research Institute WSL  
2015: WSL magazine DIAGONAL,  
2 / 15. 36 pp., ISSN 2297-6175

---

## PEOPLE



The WSL editorial team, from left to right, top row: Reinhard Lässig, Sandra Gurzeler, Bärbel Zierl, Christine Huovinen; bottom row: Martin Heggli, Lisa Bose, Birgit Ottmer

## LAB-MICROTOME

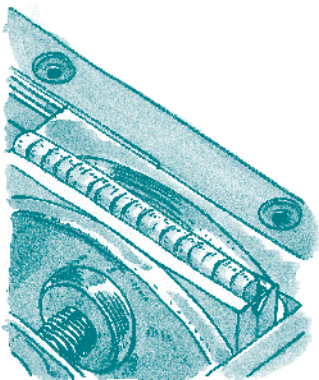
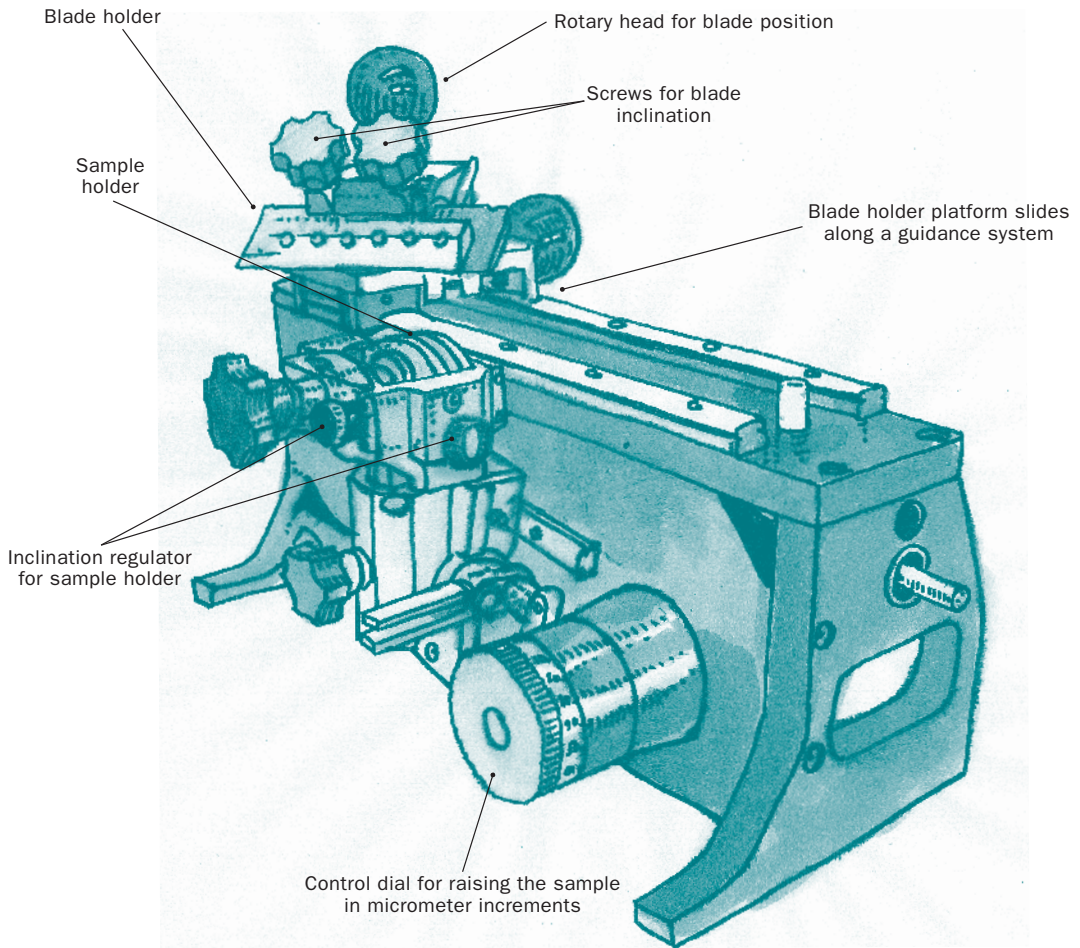

Increment core in the sample holder

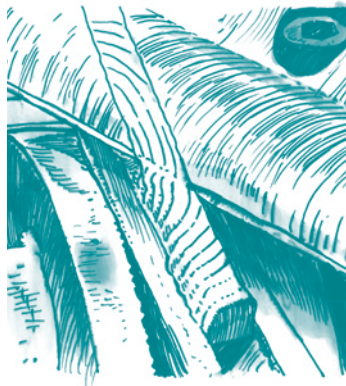

Thin section, thickness 0.02 mm

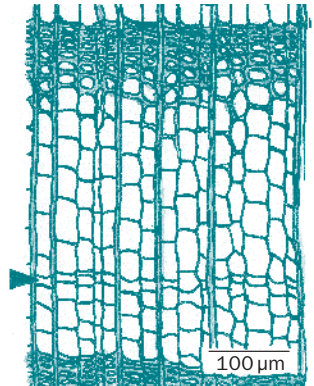

Microscopic view of a thin section

The lab-microtome is a proprietary development of the WSL. It helps to prepare thin section slides for microscopic analysis of wood samples.  
Video at: [www.wsl.ch/object](http://www.wsl.ch/object)



**Sycamore groves: El Dorado for bryophyte and lichen, p. 22**



**Expedition Greenland:** tracking the snow, p. 30



## LOCATIONS

### **Birmensdorf**

Eidg. Forschungsanstalt  
für Wald, Schnee und  
Landschaft WSL  
Zürcherstrasse 111  
CH-8903 Birmensdorf  
Phone 044 739 21 11  
Fax 044 739 22 15  
wslinfo@wsl.ch  
www.wsl.ch

### **Davos**

WSL-Institut für Schnee- und  
Lawinenforschung SLF  
Flüelastrasse 11  
CH-7260 Davos Dorf  
Phone 081 417 01 11  
Fax 081 417 01 10  
contact@slf.ch  
www.slf.ch

### **Lausanne**

Institut fédéral de  
recherches WSL  
Case postale 96  
CH-1015 Lausanne  
Phone 021 693 39 05  
Fax 021 693 39 13  
antennenromande@wsl.ch  
www.wsl.ch/lausanne

### **Bellinzona**

Istituto federale di  
ricerca WSL  
Via Belsoggiorno 22  
CH-6500 Bellinzona  
Phone 091 821 52 30  
Fax 091 821 52 39  
info.bellinzona@wsl.ch  
www.wsl.ch/bellinzona

### **Sion**

Institut fédéral de recherches  
WSL  
c/o HES-SO  
Route du Rawyl 47  
CH-1950 Sion  
Phone 027 606 87 80  
valais@wsl.ch  
www.wsl.ch/sion

## RESEARCH FOR PEOPLE AND THE ENVIRONMENT

The Swiss Federal Institute for Forest, Snow and Landscape Research WSL conducts research into changes in the terrestrial environment as well as the use and protection of natural spaces and cultural landscapes. It monitors the condition and development of the landscapes, forests, biodiversity, natural hazards, and snow and ice, and develops sustainable solutions for problems that are relevant to society – together with its partners from science and society. WSL plays a leading international role in these research areas, providing the basis for sustainable environmental policy in Switzerland. WSL employs more than 500 people in Birmensdorf, Bellinzona, Lausanne, Sion and Davos (WSL Institute for Snow and Avalanche Research SLF). It is a Swiss federal research center and part of the ETH Domain.

